

# NÁVOD K MONTÁŽI SHRNOVACÍCH DVEŘÍ

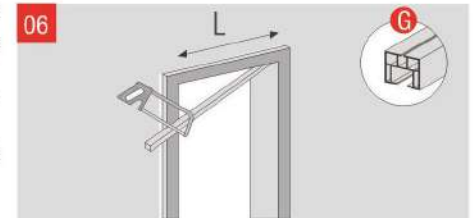

**POZOR!**

Při montáži jezdců (obr. 04) dbejte na pouze mírné dotažení šroubů jezdců. V opačném případě dochází k jejich nadměrnému zatěžování a výrazně se snižuje životnost dveří!

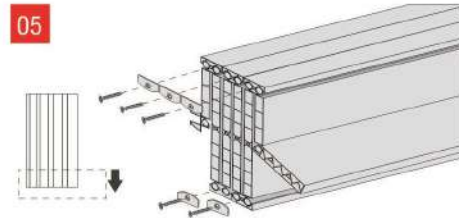
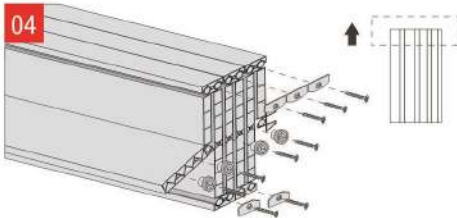
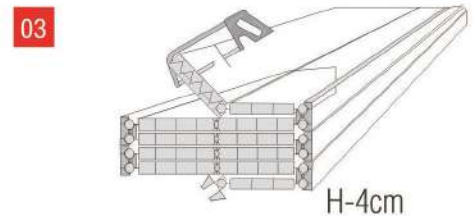
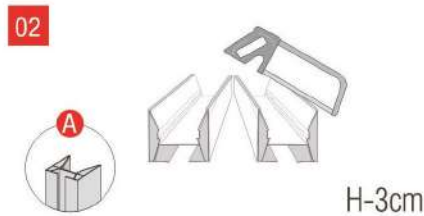
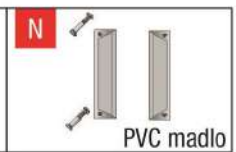
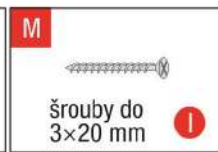
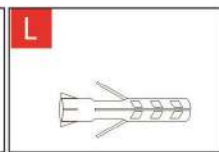
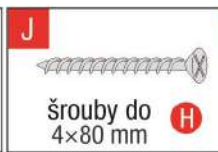
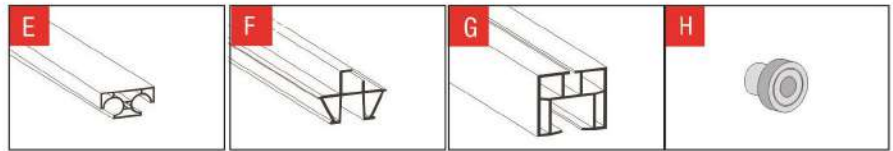
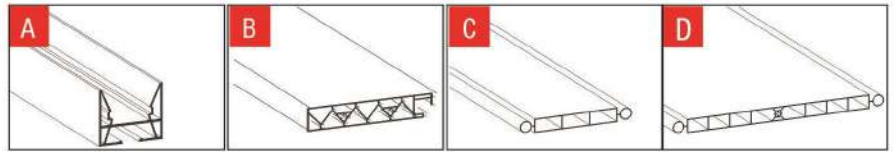
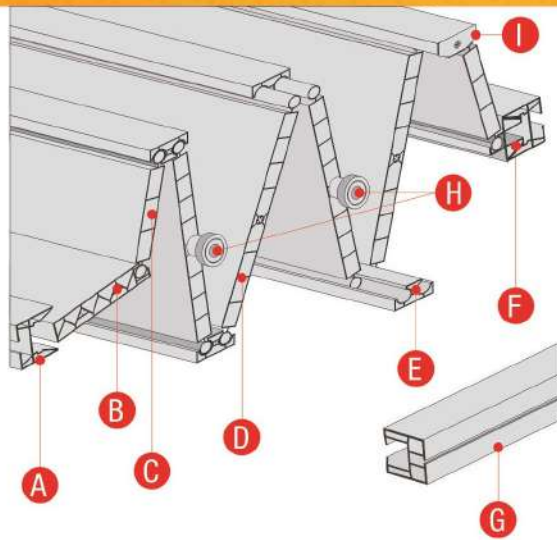
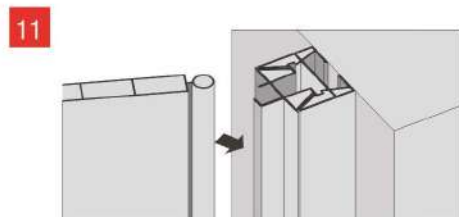
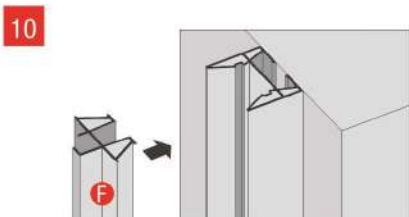
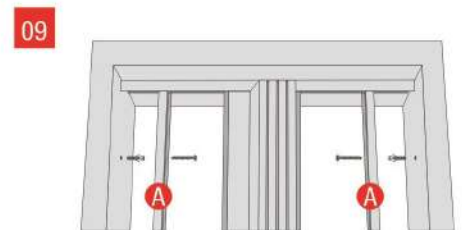
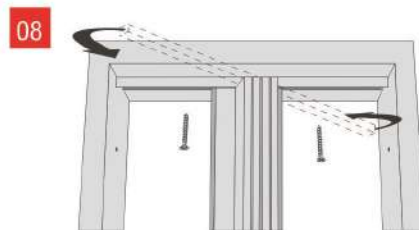
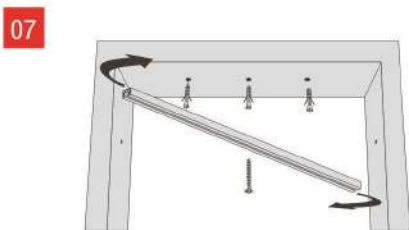

**POZOR!**

Při montáži rámových profilů A (obr. 09) dbejte na přiměřené dotažení šroubů, aby nedocházelo k tvarové deformaci profilů.

